



# LUXMAN 308

OPERATION MANUAL



110W STEREO INTEGRATED AMPLIFIER

## TABLE OF CONTENTS

Outline of Control Functions & Connections .....	2
Switches & Controls .....	4
Input & Output Terminals .....	6
Connection Procedure .....	8
Record Player .....	10
Tape Deck .....	12
Tuner, Operation of Controls .....	14
4-Channel System .....	17
Standard Curves .....	18

**T**hank you for purchasing one of our quality products, the LUXMAN L-308. With natural care, it will give you many years of outstanding performance and personal delight. Please read this Owner's Manual carefully before operating the unit. The first section diagrams the various controls, connections and summarizes their operation; Keep it handy for quick and convenient reference. The second section gives detailed descriptions and operating procedures for the electronic and mechanical components of the L-308. Again, thank you for your selection, and may "good listening" be your daily pleasure.

# Outline of Control Functions

## 1 Speaker Selector

Choice of Main or Remote (or both) and Off.

## 4 Bass

Inner axis for Left and outer axis for Right channels. Turn clockwise for bass boost.

## 6 Treble

Inner axis for Left and outer axis for Right channels. Turn clockwise for treble boost.

## 8 Linear Equalizer

The "up tilt" cuts bass and boosts treble. "down-tilt" cuts treble and boosts bass. (A full description appears on Page 16).

## 10 Low Cut

OFF at NORMAL. ON at either 20 Hz or 70 Hz. Useful for rumble filtering, etc.

## 14 Pilot Lamp

## 15 Input Selector Switch

Programme source (Phono, Tuner, Aux, etc.).

## 19 Attenuator

Keep fully clockwise for normal use. Turning counter-clockwise reduces the volume up to 18 dB. Can be used as a volume level control when the amplifier section is used separately.

## 20 Volume

## 21 Balance

Both channels are balanced at the mid-position.

## 11 High Cut

OFF at NORMAL. ON at either 7 KHz or 12 KHz. Useful for scratch filtering, etc.

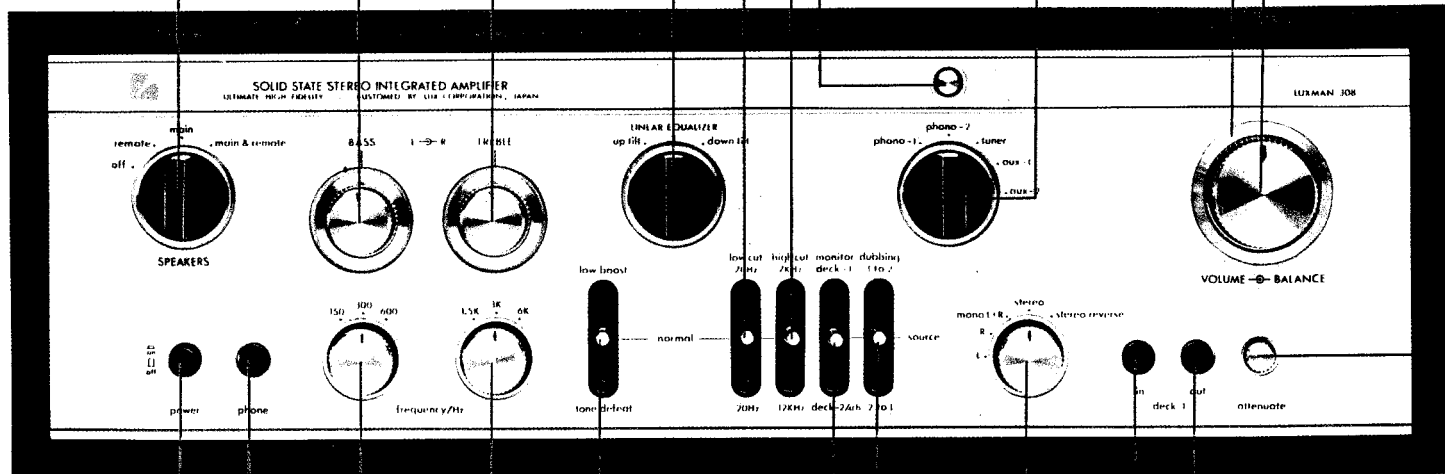

## 2 Power Switch

## 3 Phono

For connection of stereo headphones.

## 5 Bass Frequency Selector

Choice of turnover point from three frequencies.

## 7 Treble Frequency Selector

Choice of turnover point from three frequencies.

## 9 Tone Controls Switch

When at NORMAL, it allows full tone control. When at LOW BOOST, it gives an extra bass boost, and when at DEFEAT, it provides a flat response.

## 12 Monitor

Deck-1 or Deck-2/4ch for tape playback. For Phono, Tuner, Aux, etc., set at SOURCE.

## 13 Dubbing

From Tape-1 to Tape-2, move to the upper position. From Tape-2 to Tape-1, move to the lower position. Otherwise, leave at SOURCE.

## 16 Mode Selector Switch

Stereo, Monaural selection, etc.

## 17 Deck-1 Reproduction Jack

Used in conjunction with the Monitor Switch for playback from a tape-recorder.

## 18 Deck-1 Recording Jack

Used in conjunction with the Monitor Switch for recording.

# Connections

## 22 GND Terminal

For grounding the amplifier.

## 24 Phono-1

2.2mV sensitivity. For connecting the first turntable.

## 26 Phono-2

2.2 mV sensitivity. For connecting the second turntable.

## 27 Tuner Input

For connection of AM/FM/LW/SW tuner.

## 29 Aux-1

Use for a second tuner or other audio equipment.

## 30 Aux-2

Use for a second tape player or other equipment.

## 37 Main Speakers

Red terminals are positive (+); black terminals are negative(-).

## 38 Remote Speakers

Red terminals are positive (+); black terminals are negative (-).

## 41 AC Outlets (Unswitched)

Two extra outlets for AC current. Power is always available.

## 42 AC Outlet (Switched)

Power for this extra outlet depends on the Mains Switch.

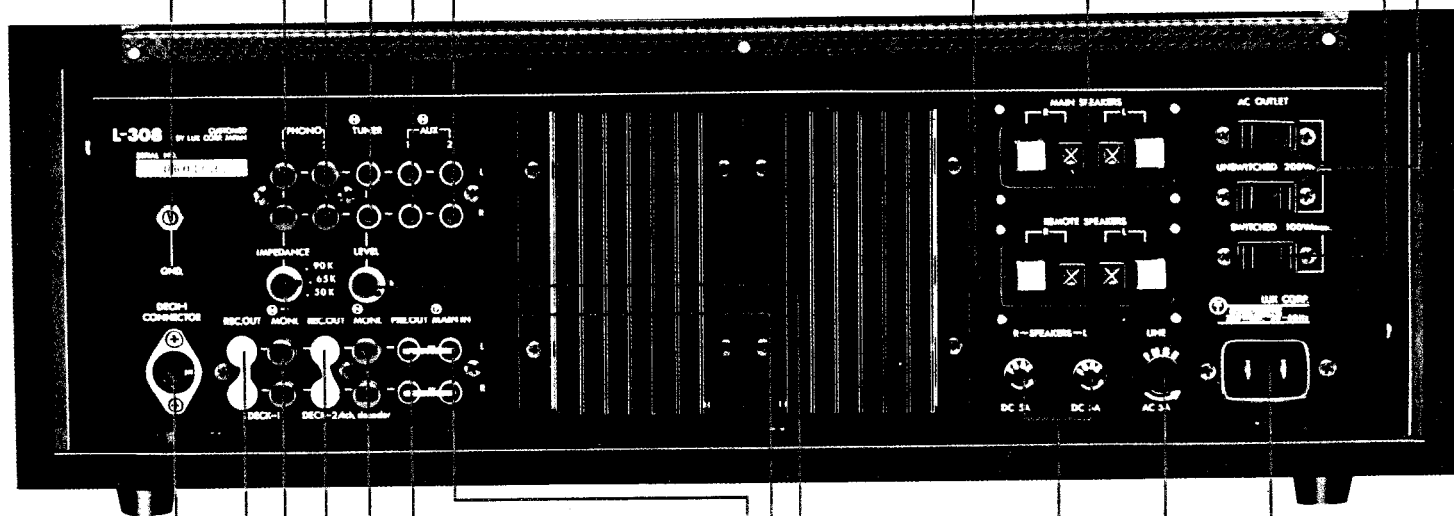

## 23 Deck-1 Connector

(DIN type) For recording and playback.

## 31 Rec. Out (Deck-1)

Connect to the input of tape-recorder 1.

## 32 Monitor (Deck-1)

Connect to the output of tape-recorder 1.

## 33 Rec. Out (Deck-2)

Connect to the input of tape-recorder 2, or connect to a 4-channel system.

## 34 Monitor (Deck-2)

Connect to the output of tape-recorder 2.

## 35 Pre-Out

For independent use of the pre-amplifier or for a multi-amplifier system with a channel divider.

## 28 Tuner-Level

Use to adjust possible volume level deviations from various programme sources.

## 25 Input Impedance for Phono-1

Check the specification for each type of cartridge and set this control accordingly.

## 36 Main In

For independent use of the main amplifier section.

## 39 DC Speaker Fuses

## 40 AC Line Fuse

## 43 Mains Power Input

# Switches & Controls

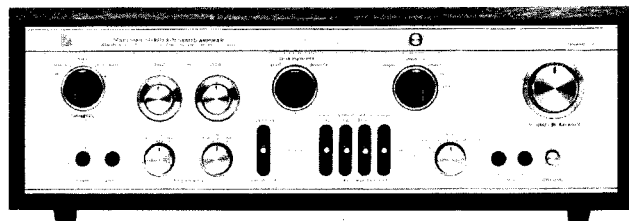

## ❶ Speaker Selector Switch (SPEAKERS)

This amplifier offers convenient use of 2 speaker systems, Main and Remote. You can choose independent or simultaneous driving of 1 or 2 systems as per the indication on the front panel. When both Main and Remote speakers are used, make sure that the overall impedance is not less than  $4\Omega$ .

At the OFF position, the speakers are disconnected from the amplifier, and you can enjoy private listening by headphone.

## ❷ Mains Switch (POWER)

Press alternately for ON or OFF.

## ❸ Headphone Jack (PHONES)

Connection of a stereophonic headphone to this jack allows private listening. Output signal is always available regardless of the position of the Speaker Selector Switch (1). For private listening, however, set the Speaker Selector Switch at the OFF position.

## ❹ Bass Level Control (BASS)

A clockwise turn of the control boosts the bass response, and a counter-clockwise turn decreases and cuts the bass. This control has a click-stopper with 11 points. It yields a flat frequency response when set at the centre of the rotation angle. You can choose a turnover (roll-off) frequency of 150Hz, 300Hz or 600Hz with the Selector Switch (5). The Bass Level Control is of dual concentric construction and permits separate control of either the right or left channels; the outer axis is for the right channel, and the inner axis is for the left channel. This control usually controls both channels simultaneously, but you may adjust either channel by holding one axis while turning the other. The click-stoppers are only for the outer axis, i.e., the right channel.

## ❺ Bass Frequency Selector Switch

Bass turn-over (roll-off) frequencies can be selected with this switch. When the desired frequency (150Hz, 300Hz or 600Hz) is set by this switch, tone control starts to function at the selected frequency. At the DEFEAT position, a flat frequency response is obtained, regardless of the position of the Bass Level Control (4).

## ❻ Treble Level Control (TREBLE)

A clockwise turn of this knob boosts the treble response, while a counter-clockwise turn decreases the treble. This control is of the same construction as that of the Bass Level Control, and its operation corresponds to that described in (4).

## ❼ Treble Frequency Selector Switch

Function wise, it is the same as the Bass Frequency Switch described in (5).

## ❽ Linear Equalizer (LINEAR EQUALIZER)

This is a new tone control which provides a tonal compensation specifically intended for subtly augmenting regular tone controls. With the control in its mid-position, flat frequency response is achieved. When switched to either of 2 "up tilt" positions, the entire response curve is rotated so as to linearly increase treble response while simultaneously decreasing bass response. Conversely, selection of a "down tilt" position rotates the response curve in a clockwise direction and provides a gradual decrease of treble and a simultaneous increase of bass. This equalizer is not released even when the Tone Controls Switch (9) is set at the "tone defeat" position. For further details, refer to the Operation of Linear Equalizer (Page 16).

## ❾ Tone Controls Switch

This switch releases the function of the tone controls (4, 5, 6, 7 above) when set at the "tone defeat" position. To operate these controls, this switch must be set at the centre or NORMAL position. It functions as a low booster at the "low boost" position where bass frequencies below 70Hz are boosted at the rate of 6 dB/oct. In case this amplifier is used as a component amplifier of a 4-channel system, take care with the phase matching of the speakers, since the phase of signals becomes reversed when they pass through the tone controls (normal or low boost), while remaining normal at the "tone defeat" position. Refer to the Operation of Low Booster and Connection of 4-CH DECODER (Page 16).

## ❿ Low Cut Filter (LOW CUT)

OFF at the centre position. When moved up to the 70Hz position, a bass roll-off occurs at 70Hz at the rate of 6 dB/oct. When moved down to 20Hz, the roll-off occurs at 20Hz. For further details, refer to Low Cut Filter (Page 16).

### 11 High Cut Filter (HIGH CUT)

OFF at the centre position. When moved up to the 7KHz position, the amount of high frequencies is reduced sharply at the rate of 6 dB/oct. When moved down to the 12KHz position, the roll-off starts at 12KHz. For further details, refer to High Cut Filter (Page 16).

### 12 Tape Monitor Switch (MONITOR)

The input function selector (phono, AUX, etc.) is separated from the volume and tone control section. If a tape recorder is not connected, and this switch is moved from NORMAL to either of the tape inputs, no sound will be heard. In case a 3-head tape recorder is used, simultaneous playback monitoring is possible while recording. In this case, the amplifier receives the playback signals either from the Tape Monitor terminals (32, 34), the Tape Connector (23) or the tape reproduction jack (17), while at the same time feeding the recording signals to the Recording Output terminals (31, 33), the Tape Connector (23), or DECK-1 recording jack (18). In case a matrix 4-CH decoder is connected to the DECK-2 Monitor (34) and Recording Output terminals (33), this lever switch must be set at the DECK-2/4ch position. For further details, refer to Connection of 4-CH DECODER (Page 17).

### 13 Tape Dubbing Switch (DUBBING)

Tape dubbing (reprinting) is possible with this switch. When the lever is set at the "1 to 2" position, the playback sound of the DECK-1 terminals can be printed on DECK-2, and vice versa when set at the "2 to 1" position. While in the dubbing process, it is possible to monitor with the Tape Monitor Switch (12). Except when reprinting a tape, it is recommended that this switch be set at the centre, SOURCE position.

### 14 Pilot Lamp

This lamp indicates that the Mains Switch (2) and the electric current are On.

### 15 Input Selector Switch

This switch permits proper selection of desired programme sources (Phono-1, Phono-2, Tuner, Aux-1, Aux-2).

### 16 Mode Selector Switch

Use this switch for selecting reproduction modes such as Stereophonic or Monaural. For further details, refer to Mode Selection (Page 14).

### 17 DECK-1 Reproduction Jack (IN)

This jack has a function equivalent to that of the Deck-1 Monitor terminals (32) on the rear panel. Plug in the line output of the tape recorder, and you can monitor by setting the Monitor Switch (12) at the "deck-1" position.

### 18 DECK-1 Recording Jack (OUT)

This jack has a function equivalent to that of the Deck-1 Recording Output terminals (31). Recording output is always available from this jack in so far as an input is given to the amplifier. If the Dubbing Switch (13) is set at the "2 to 1" position, this jack will be connected with the Deck-2 Monitor terminals, and recording output will be available from the Deck-2 terminals (33).

### 19 Attenuator (ATTENUATE)

Adjustment of this control makes it possible to pre-set efficiency of the Volume control (20) in the range of 0 dB to -18 dB (about  $\frac{1}{6}$ ). Also, since this attenuator is placed at the entrance of the main amplifier section, it can be used as an input level setter for independent use of the main amplifier section.

### 20 Volume Control (VOLUME)

A clockwise turn of this control increases volume, while a counter-clockwise turn decreases and finally cuts out volume.

### 21 Balance Control (BALANCE)

The volume balance on right and left channels can be adjusted with this control. Turn it clockwise, and the volume of the left channel will decrease; counter-clockwise causes a decrease of the right channel. When the volume of both channels is balanced, monaural reproduction sound comes from the centre of both right and left speakers. This point is usually obtained by setting the click-stopper at its centre point.

# Input & Output Terminals

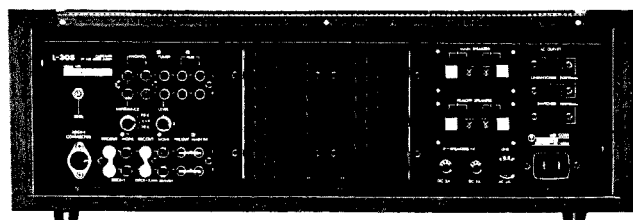

## 22 Earth Terminal (GND)

Connect the earth lead wire of the record player (from motor or pickup arm) to ground the amplifier.

## 23 Tape Connector (CONNECTOR)

This connector is of DIN standard. With the recording output terminal (REC OUT) and the tape monitor terminal in it, connection for recording and playback is feasible with a single lead-wire with DIN plug—providing the tape recorder has the same connector. For playback through this connector, the Monitor Switch (12) must be at the “deck-1” position, and the Dubbing Switch (13) at the SOURCE position. Recording output signal is always available from this connector, except when the dubbing switch is set at the “2 to 1” position.

## 24 PHONO-1 Terminal

For playback through magnetic cartridge (MM, MI, MC type). Input sensitivity, 2.2mV. Input impedance is selectable: 50K $\Omega$ , 65K $\Omega$ , and 90K $\Omega$ . Except for very low output MC type cartridge (output voltage, 0.01mV-0.1mV), almost all cartridges can be used. For such MC type cartridges of very low output level, it is necessary to boost voltage up to the specified level by use of step-up transformers or a head-amplifier.

## 25 Input Impedance Selector for PHONO-1

This selector permits selection of desired impedance: 50K $\Omega$ , 65K $\Omega$ , and 90K $\Omega$ . With MM type cartridge, frequency response varies according to load impedance. For the cartridges which tend to intensify the high frequency range, set the load impedance at the 50K $\Omega$  position. On the contrary, for those which tend to attenuate, setting at 90K $\Omega$  is recommended. Because the cartridge of 65K $\Omega$  is presently dominant in the market, this amplifier's selector is set at 65K $\Omega$ .

## 26 PHONO-2 Terminal

Same as PHONO-1 Terminal, except that the input impedance is fixed at 65K $\Omega$ .

## 27 TUNER terminal

For reproduction of tuner (AM/FM/LW/SW). The input level can be adjusted by the Level Control for TUNER terminal (28). Max. sensitivity, 100mV.

## 28 Level Control for TUNER Terminal

This is a variable resistor to set an input level of the TUNER terminal. It can be used to adjust possible volume level deviation at the time of selection of the Input Selector switch. This amplifier is delivered with volume set at the extreme counter-clockwise position.

## 29 30 AUX-1, 2 Terminals

These are auxiliary input terminals for playback of flat frequency response such as AM/FM stereo-tuner, line output of a tape recorder, or the audio output of a television receiver. Input sensitivity, 100mV. Input level is not controllable in conjunction with the Level Control for TUNER (28).

## 31 DECK-1 REC. OUT Terminal (Recording Output Terminal)

A signal for recording is taken out from this terminal (always available when an input signal is given to any of the input terminals). In case the Dubbing Switch (13) is set at the “2 to 1” position, the recording signals come from the DECK-2 recording output terminal.

## 32 “DECK-1” Monitor Terminal

Playback of the line output of a tape recorder is possible from this terminal. It is put into operation when the Monitor Switch (12) is set at the “deck-1” position. In case a 3-head tape recorder is used, simultaneous playback monitoring is possible.

## 33 “DECK-2” REC. OUT Terminal (Recording Output Terminal)

Offers the same function as the DECK-1 REC. OUT terminal (31). If the Dubbing Switch is set at the “1 to 2” position, the signal from the DECK-1 terminal is available. If the Dubbing Switch is at the SOURCE position, the recording signals are fed to both DECK-1 and DECK-2 terminals for simultaneous recording on 2 tape recorders. In case a matrix 4-CH decoder is used, this terminal has to be connected with the input terminal of the decoder with a pin jack cord.



### **34 "DECK-2" Monitor Terminal**

Functions the same as the DECK-1 terminal (32). Tape playback is possible if the Monitor Switch is set at the DECK-2/4ch position. In case this amplifier is used as a 2-CH amplifier for a matrix 4-CH system, 2 of 4 channels at the output side of the decoder should be connected to this terminal, and the Monitor Switch should be set at the "deck-2/4ch" position.

### **35 Pre Amplifier Section Output Terminal (PRE OUT)**

The whole output in the pre-amplifier section, including the tone controls and the linear equalizer, can be taken out from this terminal. Output voltage is 600mV against the standard input. When using a shield wire, there is no attenuation in the high frequencies because this terminal has sufficiently low output impedance of about 100 $\Omega$ . This terminal is for independent use of the pre-amplifier, as well as for a multi-amplifier system using a channel divider. Usually, this terminal and the Main-Amplifier Input Terminal (36) are coupled by a jumper cord.

### **36 Main-Amplifier Section Input Terminal (MAIN IN)**

The Main-Amplifier section can function independently when the signal is passed through this terminal. The input sensitivity is 600mV. The variable Attenuator (19) is inserted just after this terminal, permitting adjustment of the input level in case of the independent use of the main-amplifier section.

### **37 38 Speaker Terminals (Main and Remote)**

The speaker systems should be connected to these terminals. Press the cap of the terminal and insert the bare speaker cord into the terminal hole, then release it. Firm connection is now made. These terminals are coupled with the speaker switches, and the speaker switch must be set at the position corresponding to the terminal to which the speaker systems are connected. 37 is for the main speaker, and 38 is for the remote speaker. The red terminal is for (+) and the black for (-). For further details, refer to Connection of Speakers (Page 9).

### **39 DC Fuses (RIGHT and LEFT SPEAKER)**

Short circuit of the speaker terminals or extremely low impedance given by the speakers may cause the DC fuses to blow out. In such a case, ascertain the cause and correct it. Replacement of the fuses is done by turning the fuse cap in the direction of the arrow mark and inserting new fuse. Be sure that the mains cord is disconnected.

### **40 Mains Fuse**

A 5A fuse is inserted in the mains power circuit of this amplifier. If the fuse blows out, replace it, ascertain the cause and correct it. Replace the fuse by turning the cap in the direction of the arrow mark. Be sure that the mains power cord is disconnected.

### **41 Extra Mains Outlets**

Convenient for supplying mains power to other equipment such as AM/FM tuner or record player. The terminals (41 UNSWITCHED) are independent of the mains switch of the amplifier, while the other (42 SWITCHED) is coupled with the mains switch. The supply of the mains power depends on the mains switch. The total capacity for the UNSWITCHED (41) terminals is 200W. The rated capacity for the SWITCHED (42) terminal is 100W.

### **43 Mains Connector**

One end of the attached mains cord should be connected to this point, while the other end with plug should be connected to the mains power supply.

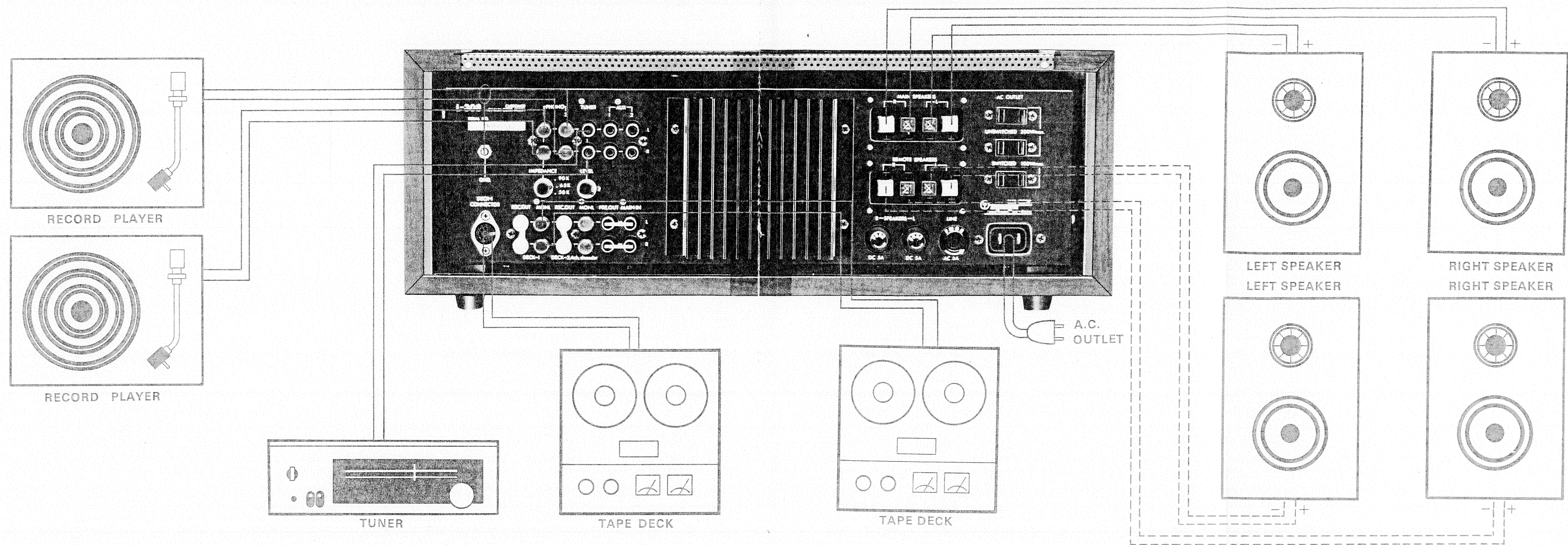

# Connection Procedure

## Basic Connection:

This amplifier is composed of a pre-amplifier section, which controls playback equipment, and a power amplifier section, which amplifies the signal to the extent that it drives the speaker systems. It functions as the stereophonic reproduction system when the player, tuner, etc. are connected to the input terminals and the speakers or headphone to the output terminals. Thus it is basically necessary to connect this amplifier with the input source, output loads and, naturally, the mains current.

## Connection to Input Terminals:

Connect the outputs of player, tuner, or tape-recorder to the relevant input terminals of this amplifier. As to the details, see the section on Playback of Disc, Tuner and Tape-Recorder.

## Connection Cable (Cord Wire):

For connection of the record-player, tuner, and tape-recorder, shield wire is used for protection from external noise or inductance noise. Usually, this shield wire has the capacitance of approx. 300pF/M, i.e., the adoption of a connection cable gives the same effect as that of the insertion of a capacitor in parallel with input sources or output load equipment (which composes a kind of high-cut filter circuit). For instance, 2 meters of this shield wire has 600pF capacitance, and if this cord is used at the point where parallel composite value of input and output impedance is 50K $\Omega$ , it means an insertion of a high-cut filter with cut-off frequency at about 10KHz, which causes an unnecessary attenuation of the high frequency range. Use of the shortest wire is, therefore, recommended, especially for high impedance equipment.

Choose a shield wire of good quality and make it as short as possible for connection of this amplifier (at PHONO, AUX, Tape-monitor, tape jacks etc.) with the high impedance equipment. In case input or output impedance is sufficiently low, the effect is not much, since parallel composite impedance becomes lower and cut-off frequency will be shifted out of the audible range. It does not matter if relatively long cable is used for the pre-amplifier output and recording output (REC OUT) terminals, since their impedances are so designed as to be sufficiently low (approx. 100 $\Omega$ ).

## Connection of Speakers:

Stereophonic playback is made with a pair of speaker systems for right and left channels. This amplifier is provided with 2-channel terminals for main and remote speakers. Connection can be made in the same manner.

The right speaker system should be connected to the Right speaker terminals, and the left speaker system to the Left terminals.

Note that perfect sound reproduction cannot be expected if the phase is not matched between both channels. To match the phase is to connect the (+) terminal of the right speaker to the (+) terminal (red cap) in the right channel of this amplifier, and the (-) terminal to the (-) one (black cap). Do the same with the left speaker. If mismatched for some reason (e.g., mis-connection of speakers), the low frequency range is subdued and stable playback cannot be realized.

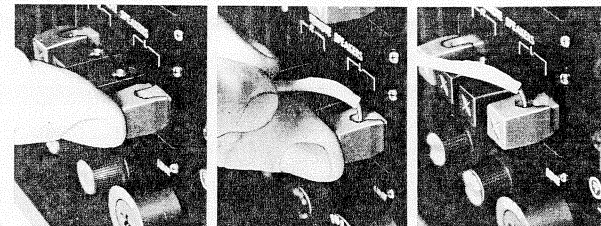

To firmly connect the speaker terminals, strip off the end of the shield wire by 10mm and insert it into the terminal hole by pressing the terminal head, and then releasing it.

After connection of the speakers, set the speaker selector switch so that 2 pairs (main and remote) of speaker systems can be simultaneously or independently driven.

## Connection of Main Power Supply Source:

As the final step of preparation, connect the amplifier to the mains power supply source. One end of the flex should be connected to the mains connector on the amplifier, and the other end should be plugged into the power supply outlet. Then press the power switch. The pilot lamp lights up and the amplifier will function in about 2~3 seconds.

The power for other audio equipment used in combination with this amplifier can be obtained from the extra power outlets (SWITCHED) of the amplifier. In this case, on/off switching of the amplifier is common to other annexed audio equipment, i.e., if the power switch of the amplifier is switched on, the power switch of the other audio unit works simultaneously.

# Record Player

## Connections:

The player has 2 cords with pin plugs at their ends for both right and left channels. Connect the pin plugs to the input terminals of this amplifier (PHONO-1 (24), PHONO-2 (26)). The player's earth lead can be connected to the GND terminal (22). The player's power flex can be connected to the extra power outlet (41) of the amplifier.

This amplifier is provided with 2 input terminals (PHONO-1 & PHONO-2) to be selected by the input selector switch. This is useful for comparison or using two record players. For use of one player, either of the two input terminals can be selected. But in case MM-type cartridge (Moving Magnet) is used, it is advisable to use PHONO-1, since its impedance can be varied (using the impedance selector at the bottom) to give a proper load to the cartridge.

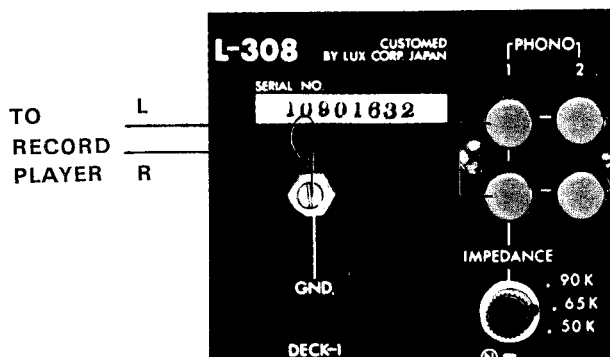

## Signal Paths:

Put the disc on the turn-table, switch on the phono motor, and set the stylus on the groove of the disc. Then recorded signals begin to be fed to the amplifier. First, the signals fed to the amplifier through PHONO terminals are brought to the equalizer section, where recorded signals are restored to the original frequency curve. Incidentally, this equalizer curve has been standardized to the RIAA curve. The equalized signals are then fed to the input selector switch (function switch). If this switch is not set at PHONO position, the signals are blocked here and no amplification is possible.

After equalization, the signals are divided into two channels at sufficiently low impedance (about 100Ω to prevent possible high frequency attenuation caused by long cables or floating

capacitance) by the emitter-follower stage annexed at the last portion of the equalizer section. From here, one line goes to the REC OUT terminal, and the other to the tape monitor switch. If the Monitor Switch (12) is set at the "SOURCE" position, the signals are sent to the mode selector switch, balance and volume controls, but if at the "DECK-1" or "DECK-2" position, the signals are stopped at the tape monitor terminals. Except during tape playback, the monitor switch must be kept at the "SOURCE" position. But when the input signals are fed to PHONO or AUX terminals, recording output is always obtainable regardless of the position of the monitor switch. Then the signals are sent to the volume control through the mode selector and balance control.

Such controls as Linear Equalizer, Low-cut filter, High-cut filter, Attenuator, Low booster, and Tone controls are for flexible and diversified adjustment of playback sound and do not block the signals completely.

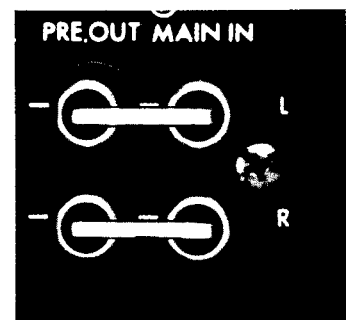

As long as the pre-main Jumper connector is hooked, the signals reach the speaker circuits amplified by the main amplifier. Sound reproduction from speaker systems is thus realized if the Speaker Selector switch is set at the position corresponding to the speaker terminals to which the speakers are connected.

## Playback

Put a disc on the turn-table for playback. As the volume control is turned clockwise, playback sound comes from the speakers. As explained above, playback is possible regardless of the position of the Mode Selector, etc.. Input Selector Switch (15), Monitor Switch (12), Pre-Main Amplifier Connection Jumper, Speaker Switch (1) and Volume Control (20) should be set at the correct positions. After all preparations are completed, check if the volume levels on both right and left speakers are identical. If different, adjust them with the Balance Control. For Stereophonic playback, set the Mode Selector Switch to the STEREO position.

## CARTRIDGES

### Types

There are various types of cartridges: magnetic type, photo-electric type, electrostatic type and piezo-electric type. Most predominate is the magnetic type which includes the MM (Moving Magnet), the IM (Induced Magnet), the MI (Moving Iron) and the MC (Moving Coil). The PHONO terminals of this amplifier are designed to match with these types of magnetic cartridges, but a cartridge of low output level (output voltage 0.01 to 0.1mV) cannot be directly connected. (Refer to the Step-up Transformer for MC Type paragraph.)

If using the photo-electric or electrostatic type cartridge, choose appropriate input terminals according to the explanation sheet of the cartridge. Among the piezo-electric types, there are crystal types and ceramic types. Generally, these types can be connected to the AUX terminals, but the equalizer characteristic will be incorrect (further equalization will be needed). For this reason, they are seldom used in high class units.

### Input Impedance

The PHONO-1 input terminals (24) are coupled with a 3-step (50K $\Omega$ , 65K $\Omega$  and 90K $\Omega$ ) impedance selector (25) on the rear panel. Except for a special low impedance type cartridge, almost all currently marketed cartridges specify recommended load impedance of 30/100K $\Omega$ . In this range, the cartridge with a 65K $\Omega$  load impedance is by far predominate. It is known that variation of the load impedance value affects the frequency response to a great extent. The graph shown here illustrates this point.

Notice that a low load impedance cuts treble output, while a high load impedance causes a peak in the treble range. The degree of such effect is not the same with different cartridges, but generally a cartridge having a higher output impedance tends to be more delicately influenced. It is therefore necessary that selection of a proper input impedance is made with this control.

### Step-up Transformer Unit for MC Type Cartridges:

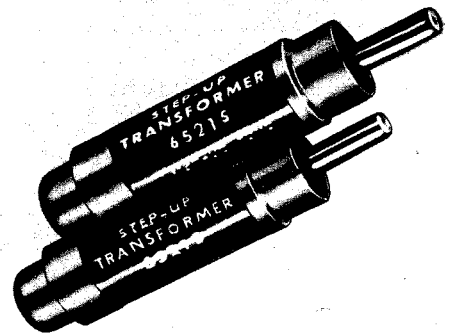

This amplifier does not have connectors for exclusive use of a step-up transformer. However, if input voltage step-up is desired, use of the LUX model 6521S pin-plug step-up transformer unit is recommended. This completely new step-up transformer is extremely compact and features highly efficient performance. Fitting of this transformer to the amplifier is accomplished through the PHONO terminals. By using this transformer, low output level phonograph signals from a MC (Moving Coil) cartridge can be boosted by 30 times.

The core of the transformer is made of super-permalloy material to ensure superb frequency response. Bisection winding coil construction and complete shielding provision for the core perfectly eliminate induced noise from external sources.

Specifications (6521S trans unit, 2 pcs. as a pair)	
Primary end impedance	Less than 4 $\Omega$
Secondary end impedance	More than 30K $\Omega$
Step-up ratio	1:33
Frequency response	40 to 30,000Hz
Output voltage distortion	500mV, 0.02%
Induced noise level	Less than -80dB/m
Weight	12 grams

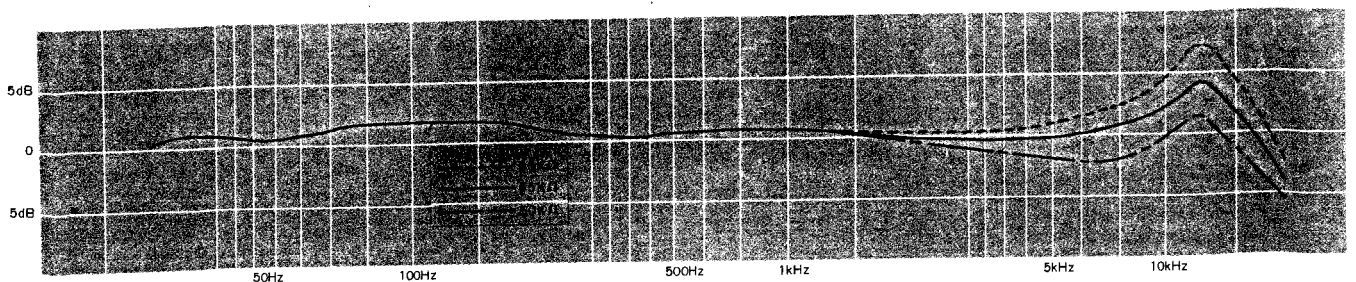

Effect of the Load Impedance on the frequency response.

# Tape Deck

## Playback from Tape Monitor Terminals:

Almost all tape-recorders and tape-decks currently marketed include an audio amplifier in their circuitry, and some tape-players are made exclusively for playback.

Connect the output terminal (LINE OUT) to the Tape Monitor terminals (32) & (34). Then set the Monitor Switch at the corresponding position to which the tape-recorder is connected. If two tape-recorders are connected to the terminals (32) and (34), selection between either unit is possible by the Tape Monitor Switch (12).

This amplifier can be divided into two sections: one before the Recording Output terminals (REC. OUT) and the other after the Tape Monitor Switch. A 3-head tape-recorder makes it feasible to make recordings with the former section and simultaneously make playback with the latter section.

Note that a normal function cannot be expected if 2 or 3 sets of tape-recorders for playback are connected to the terminals of TAPE-1, Tape Connector (23) and the Deck-1 playback jack (17) at the same time, since these three are coupled in the inside circuit and affect each other. Therefore, if the Tape Monitor terminals and the Tape Connector are used, the tape-recorders should be connected to the terminals of TAPE-2 (with the Monitor Switch at the Deck-2 position) and to the Tape Connector.

## Playback from AUX Terminals:

Playback of tape is possible if the line output of the tape-recorder or tape-deck is connected to the AUX terminals of this amplifier by use of a pin-jack lead, and the Input Selector Switch is set at the position corresponding to the AUX terminals. All operations in this case are the same as those for the playback from tuner (Page 14).

Note that when tape playback is made through the AUX terminals, the line input or AUX input terminals of the tape-should be kept free. If connected to the Recording Output terminals (REC. OUT) of the amplifier, there will be possible oscillation by feed-back of signals.

## Playback from Tape Connector:

This is a DIN connector and is convenient for simple connection with a patch cord between the tape-recorder and recording/playback connectors of this amplifier. Playback from the Tape Connector is possible if the Monitor Switch is set at the DECK-1 position. (Make certain to use DIN cord only, since the impedance at REC OUT terminals is kept at  $80K\Omega \pm 10K\Omega$ .)

## Playback from Tape Jacks:

When the Tape Playback Jack (17) and the line output of the tape-recorder are connected and the Monitor Switch (12) is set at the DECK-1 position, playback from the tape jack is possible. In this case, it is necessary to modify the pin-jack cord to the plug-cord as shown below.

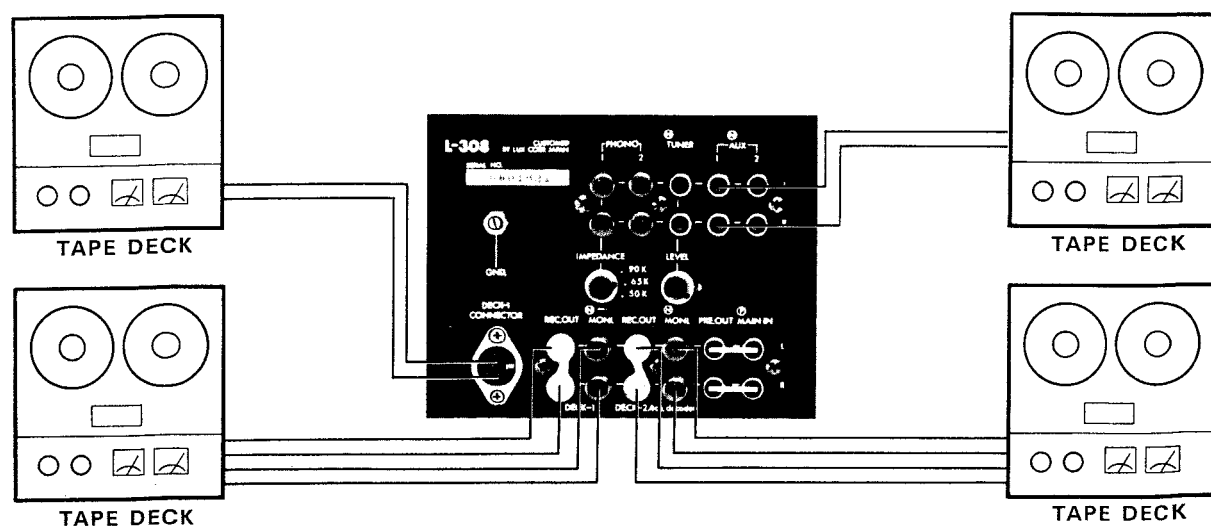

### Recording on Tape:

In case of playback of various programme sources through input terminals of this amplifier, the same signals as those reproduced in the speakers are always available at the REC OUT terminals (31, 33) and the Tape Connector (23). By connecting these terminals to the input terminals (AUX or LINE IN) of the tape-recorder, you can enjoy simultaneous recording and playback. (It is recommended that the Dubbing Switch be kept at the SOURCE position.) These recording signals are taken out before the tape monitoring stage, and there is no influence on the Filters, Volume or Tone Controls, etc., as far as the quality of the recorded signal is concerned.

### Tape Dubbing (REPRINTING)

With this amplifier, it is possible to reprint from one tape-recorder to another. Connect the line output terminals and the line input (or AUX) terminals of one tape-recorder to the DECK-1 Monitor and REC OUT terminals of the amplifier. Like-

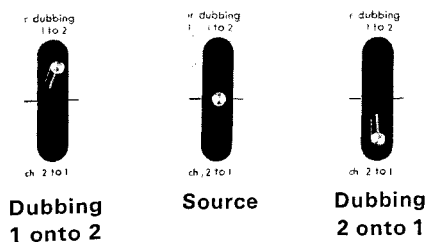
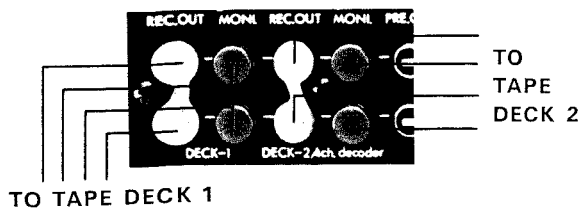

wise, connect the line input and output of the other tape-recorder to the DECK-2 terminals. Dubbing is now possible by use of the Dubbing Switch. At the "1 to 2" position, the tape of DECK-1 terminals can be reprinted on the tape of the DECK-2 terminals, and vice versa at the "2 to 1" position. In this way, repetition of switching between SOURCE and "1 to 2" or "2 to 1" makes possible a comparison of the master tape and the reprinted tape. Except when actually dubbing, it is recommended that the Dubbing Switch be set at the SOURCE position.

### Simultaneous Playback Monitoring:

A 3-head tape-recorder ensures simultaneous playback monitoring and recording. In this case, recording on tape and playback of the recorded sound is done at the same time, and connections must be made for both functions. It is necessary to connect the REC OUT terminals (31 or 33) to the line input terminals (AUX Input) of the tape-recorder, and the Tape Monitor terminals (32 or 34) to the output terminals (LINE OUT) of the tape-recorder.

The Tape Monitor Switch (12) is set at the position corresponding to the terminals to which the tape-recorder is connected, and repetition of switching between SOURCE and DECK-1 or DECK-2/4CH allows a comparison to be made between the original and the recorded sound. Possible recording errors can thus be prevented. Incidentally, note that reproduction of recorded sound becomes a little delayed as compared with that of original sound since there is a gap between the recording head and the playback head.

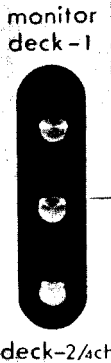

Simultaneous playback monitoring can be made through the Tape Connector (23) as well. A single piece of DIN cord ensures connection for recording and playback on the Tape Connector, and simple operation of switching between SOURCE and DECK-1 is sufficient.

### Simultaneous Recording:

This amplifier is provided with two sets of REC OUT terminals~enabling simultaneous recording on two tape-recorders. If desired, a combination of recording on open-reel recorders and/or cassette recorders can be accomplished. Moreover, if the Tape Connector and Tape Jack are used, recording on four tape-recorders or combinations is possible. The Dubbing Switch must be set at SOURCE in this case.

This facility is useful for safer printing, effective recording, etc.. As the impedance at the REC OUT terminals is kept sufficiently low (about 100Ω), mutual interference will be almost nil between the recorders under simultaneous recording.

### Playback from Other Sources:

The signals of flat frequency response from such sources as TV receivers do not need an equalizer stage. For playback of such audio equipment, either of the AUX terminals or the TUNER terminal can be used. Connection and operation is the same as that of a tuner.

# Tuner

# Operation of Controls

## Playback from Tuner

Connect the tuner's output terminals (left and right) to either of the amplifier's AUX terminals (29 or 30) or to the Tuner terminals (27).

The Input Selector Switch (15) must be set at the corresponding position. As shown in the block diagram, the input signals from the tuner are fed directly to the input selector circuit. Afterwards, the signals trace the same blocks as are explained in the TAPE DECK section and are reproduced from the speaker systems. Both for FM stereophonic and monaural broadcasting, the Mode Selector Switch should be set at the STEREO position, for such accommodation to the input source can be made in the tuner. Modulation hum in the AM programme can be eliminated by varying the distance and angle of these components.

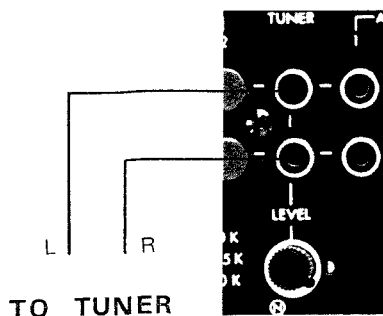

## Input Level Control:

The TUNER, AUX-1 and AUX-2 terminals are all for auxiliary input terminals for the reproduction of flat frequency response. For the TUNER terminals (27), a LEVEL CONTROL (28) is provided. The input sensitivity is 100mV when the control is at the extreme clockwise position. Any sensitivity exceeding 100mV can be obtained by turning the control counter-clockwise.

If other programme sources are connected to the AUX terminals, possible deviation of the input level among the various sources can be adjusted by the LEVEL CONTROL if the programme source with the highest output is connected to the TUNER terminals.

## Mode Selector:

This amplifier is for stereophonic reproduction and incorporates independent amplifiers for two channels (right and left). Without the Mode Selector, the signals fed to the right channel terminal are reproduced at the right channel speaker only. The Mode Selector is placed between the two amplifiers to change the mode of reproduction.

Mode Selector Chart

knob position	connection		performance	use
	input	output		
STEREO NORMAL	R → R	L → L	normal stereo playback	for normal stereo playback
STEREO REVERSE	R → L	L → R	reversed stereo playback	when program source is reversely connected
MONO R	R → R	L → R	right input signal is reproduced from both right and left speakers	for monaural program source playback
MONO L	R → L	L → L	left input signal is reproduced from both right and left speakers	
MONO L+R	R → R	L → L	right and left input signals are integrated	for playback of monaural record with a stereo phono pick-up

## Volume Control:

The variable resistor of this control yields an A type curve. In the attenuation characteristics of A type, the turning angle is proportionate to the attenuation degree (dB), the dB value and the volume audible to human ears. In other words, the rotation of the control is in proportion to the sound volume felt by human ears. The increasing degree of volume is felt quite naturally as the control is turned in the clockwise direction.

## Attenuator Switch:

This switch should normally be kept fully clockwise for maximum sensitivity. When turned to the minimum position, the volume is reduced by up to 18dB (about 1/8 power). If, however, you should be using high efficiency loudspeakers, such as horn-loaded types, setting the switch half way will make the main volume control easier to use.

Another use for this switch is as follows; If you wish to use the main power amplifiers separately, then this switch will adjust their input sensitivities to match your other equipment.

### Balance Control:

In case of deviation between the volume levels of right and left channels, adjust the unbalanced volume level with this control (21). A complete turn of the control to either the clockwise or counter-clockwise direction causes a cut off of the volume of the other speaker. The volume balance of both channels can be adjusted so that monaural disc sound reproduced by the stereo cartridge comes from the centre of the right and left channels. At mid position, the volume of both channels is adjusted to the same level. Thus, a proper balance is established through all playback stages. If a programme source is unbalanced (or the speakers are placed in an oblique position), establish the correct balance with this control.

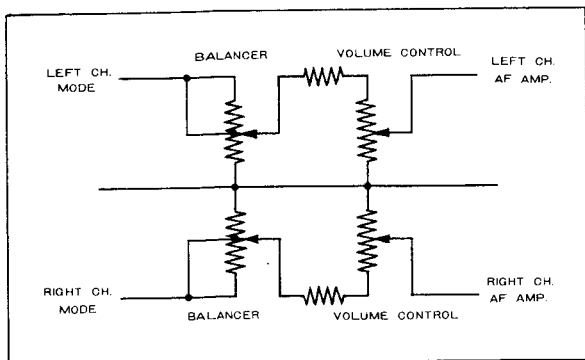

### Tone Controls:

The ultimate purpose of the audio system is to make high fidelity reproduction of programme sources. The reproduction and acoustic conditions do not always match with recording conditions, and it is impossible to reproduce the same sound as the original. Also, there is no objective standard to judge a good sound from an inferior one. The only possible solution is for every listener to create his favorite sound according to his own taste. It is therefore very important that the audio system offers a facility to permit flexible controls for creation of the best sound.

This amplifier is equipped with the LUX original NF type turn-over (roll-off) frequency selector for subtle and minute control of the reproduced sound. Tone controls include Bass Level Control (4), Bass Frequency Selector (5), Treble Level Control (6), Treble Frequency Selector (7) and Tone Controls Switch (9).

If the Tone Controls Switch (9) is set at the DEFEAT position, flat frequency response is obtained regardless of the position of the level controls and frequency selectors. After setting the Tone Control Switches (9) at the NORMAL position and controlling the levels and frequencies as desired, you can again obtain flat

frequency response by resetting the Tone Controls Switch at the DEFEAT position: controlled tone and flat tone can be easily recognized.

The Bass Frequency Selector (5) has three positions: 150Hz, 300Hz and 600Hz. From the position selected, Bass Level Control (4) begins to function. In other words, turn-over (roll-off) of a lower frequency range below the frequency which has been selected can be controlled by the Bass Level Control (4). The controllable range is wider by 150Hz, 300Hz and 600Hz respectively.

The Bass Level Control, which functions in conjunction with the Bass Frequency Selector, is a tone control of the lower range of the frequency response. It is designed so that response is flat at the mid-position. A clockwise turn intensifies the low frequency range, while a counter-clockwise turn yields attenuation. For easy adjustment, the control is equipped with an 11-point click-stopper.

This control is of dual concentric construction, and usually both channels are controlled simultaneously. Separate control of either channel is possible if one axis is turned while the other is held by hand. The inner axis is for the left channel and the outer axis is for the right channel.

These same descriptions are applicable to the Treble Level Control (6) and the Treble Frequency Selector (7). The Treble Frequency Selector has 3 positions: 6KHz, 3KHz and 1.5KHz (controllable range is wider in this respective order). Treble control begins to function from the position that is selected. This control also has an 11-point click-stopper, and a clockwise turn boosts the high frequency range. It is of dual concentric construction like the Bass Level Control.

For details of these tone controls' characteristics, refer to the attached chart concerning the response curve. Mode Chart

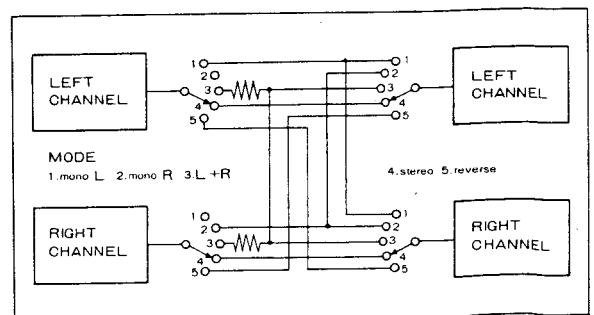
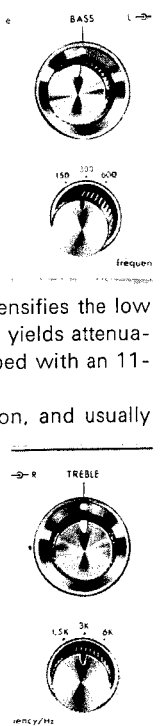



### The Linear Equalizer:

Although recordings are equalized in accordance with RIAA standards, it is quite common to encounter variations in overall tonal balance from one recording to the next. In addition, differences in listening environment and room acoustics often require subtle degrees of tonal compensation that conventional tone controls cannot correct because of their wide range and overlapping crossover characteristics.

THE LINEAR EQUALIZER control provides a new form of tonal compensation specifically intended for subtly augmenting regular tone controls. With the control in its mid-position, flat frequency response is achieved.

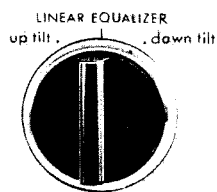

Switched to either of the two "up-tilt" positions, the entire response curve is rotated about a 1KHz fixed axis so as to linearly increase treble response while simultaneously decreasing bass response. Conversely, selection of one of the "down-tilt" positions rotates the response curve in a clockwise direction, providing a gradual decrease of treble response and simultaneous increase of bass response. Degree of slope for either positive or negative settings has been carefully preset, and the overall response curve maintains complete linearity from 50Hz to above 10KHz, unlike the curvature in response normally associated with ordinary tone controls.

Specifically, when the control is turned to the first "up-tilt" position, it will decrease bass and increase treble by 1.5dB at 100Hz and 10KHz respectively, while selection of the second "up-tilt" position will result in a 3dB cut and boost at these same frequencies. Selection of the first "down-tilt" position will decrease treble and increase bass by 1.5dB at the same reference frequencies, while the second "down-tilt" position provides 3dB of cut (at 100Hz) and boost (at 10KHz).

Combined use of the LINEAR EQUALIZER and conventional tone controls provides a degree of tonal flexibility which cannot be achieved with any other tone control arrangement presently available. Because of the inherently linear nature of this new circuit, it introduces no increase of harmonic distortion at any of its settings.

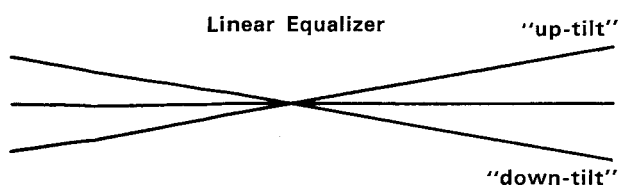

### Low Cut Filter:

When this filter (10) is moved up from the centre NORMAL position, the low frequencies you hear are cut off below 70Hz at the rate of 6dB/Octave. When, it is moved down, the low frequencies are cut off below 20Hz. Thus, it is useful for removing low frequency noise such as rumbling of the phono motor. It can also be used as an auxiliary control for Bass Level Control.

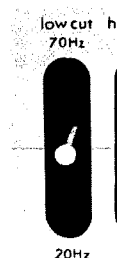

### High Cut Filter:

When this filter (11) is moved up from the centre NORMAL position, the high frequency range over 7KHz is cut off at the attenuation rate of 6dB/Octave. When moved down, the high frequencies over 12KHz are cut off. Thus, it is useful for removing scratch or hissing noise and can also be used as an auxiliary control for Treble Level Control.

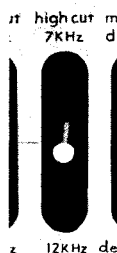

### Operation of Low Booster

The Tone Controls Switch (9) has two functions: tone defearer and low booster. When this switch is set at the LOW BOOST position, the low frequency range below 70Hz is boosted with a slope of 6dB/Octave in addition to other tone controls. This circuit, effective only on the extreme low frequency range, allows flexible and versatile tone adjustment. For instance, probable rise-up in a small room of approximately 10m<sup>2</sup> in the neighbourhood of 150 to 200Hz can be subdued with this control by lowering the bass level to the 300Hz position on the Bass Frequency Selector. This process can suppress such unnecessary rise-up without spoiling the response at the extreme low frequency range. Moreover, when the human voice sounds unnaturally stout, it can be adjusted to a clear, natural voice by switching on this booster and cutting the low frequency range a small extent with the Bass Level Control.



# 4-Channel System

At present, there are many 4-channel systems available. Of these, the three most popular systems are the CD-4® (completely discrete disc), the R.M.® (Regular Matrix) and the S.Q.® systems. Even though the LUXMAN L-308 is a 2-channel amplifier, it can be used with other equipment to provide 4-channel sound.

If you use a CD-4® de-modulator unit, there will be four output terminals. Connect two of these (such as Left-Front and Right-Front) to the AUX-1 input terminals of the amplifier. For details, refer to the De-modulator Instruction Manual.

If you use either the R.M.® or S.Q.® system, again connect two of the four outputs to the AUX-1 inputs. However, most of the available de-modulators do not have built-in Phono amplifiers. Therefore, to use a de-modulator with your record-player, connect the inputs of the de-modulator to the Tape-1 outputs of the amplifier and use the amplifier's Phono-1 inputs for the turntable. For more details, consult the De-modulator Instruction Manual.

A word of caution! For correct phasing, there are marks on the back panel: ⊕ over the Tuner, Aux, and Monitor inputs and ⊖ over the Main-In terminals. These marks mean that the speaker output is in phase ⊕ or out of phase ⊖ with the inputs.

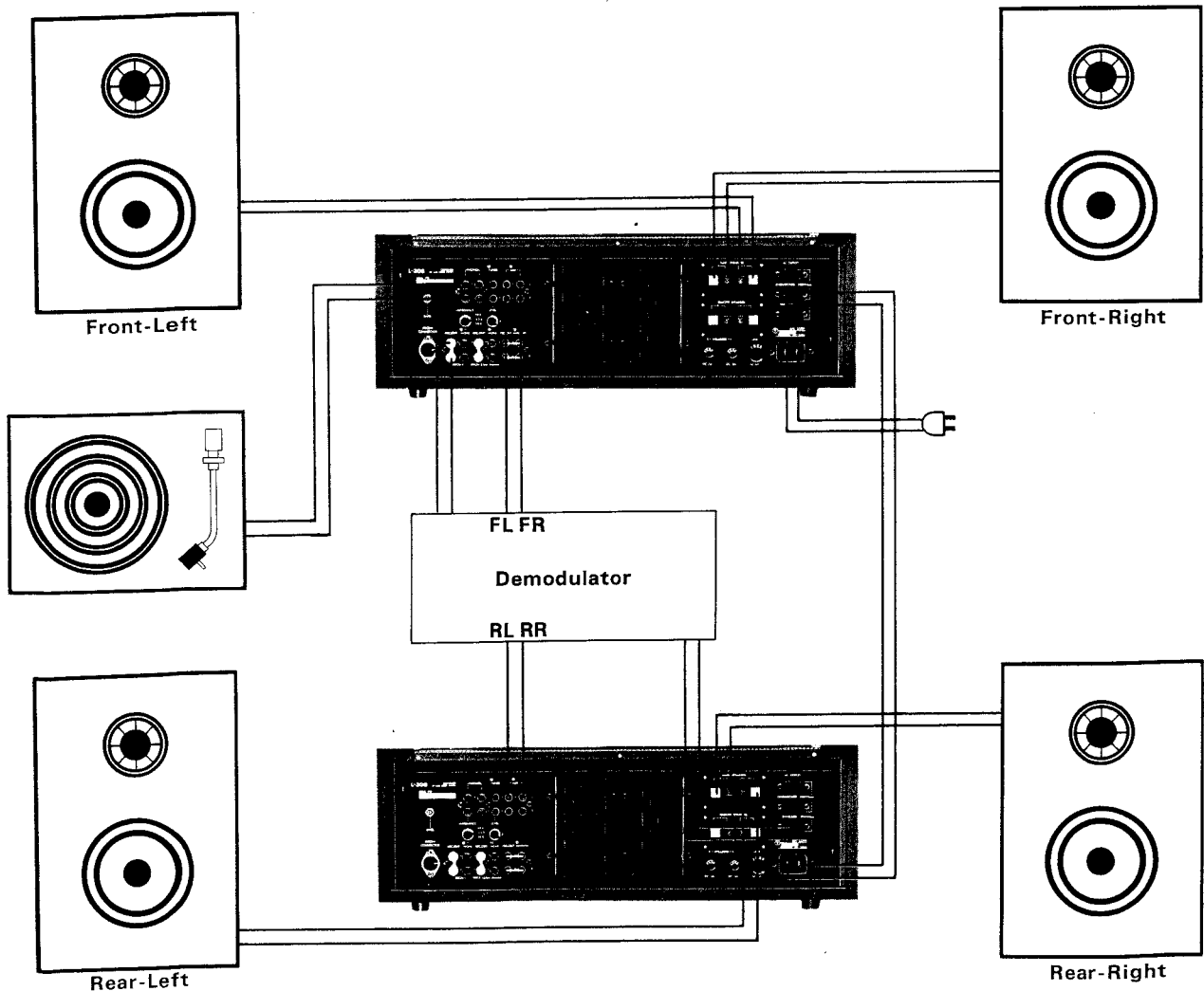

# Standard Curves

T.H.D. Vs. POWER

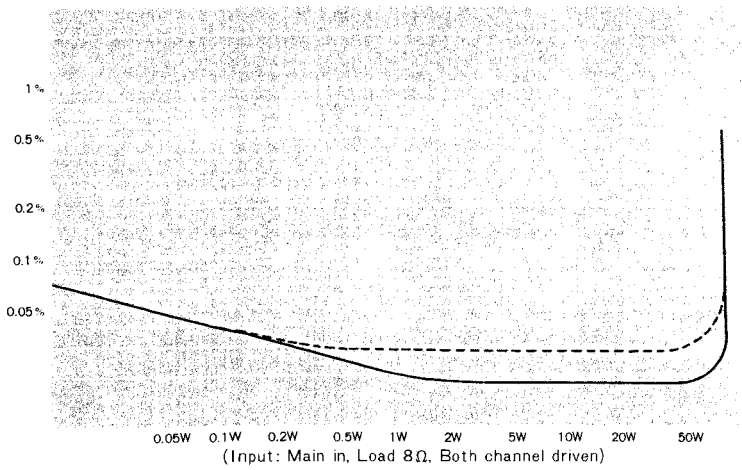

PHONO Input Voltage (Output: REC. OUT Terminal)

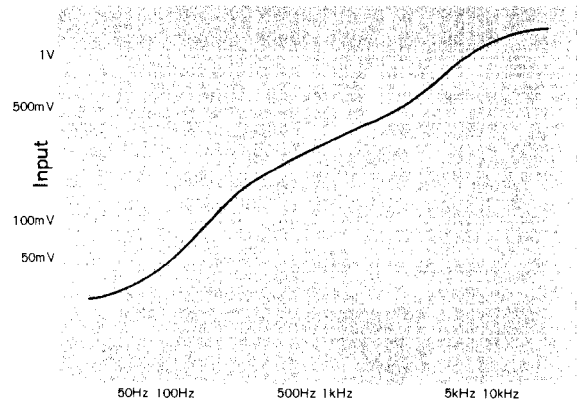

I.M.D. Vs. POWER

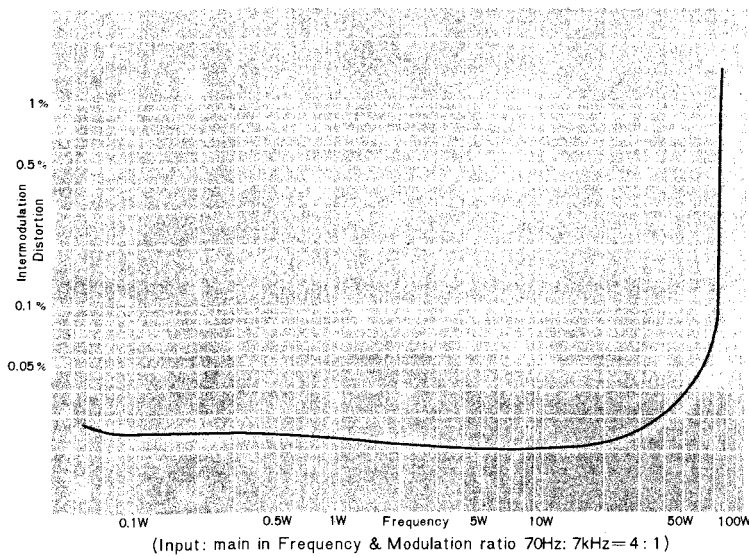

Equalizer (Output: REC. OUT Terminal)

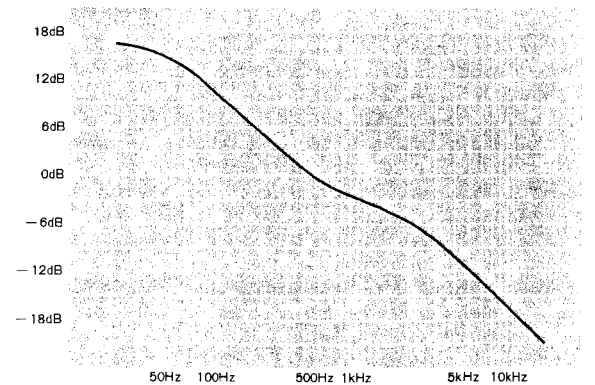

**POWER BANDWIDTH** 8Ω load 0dB:30W

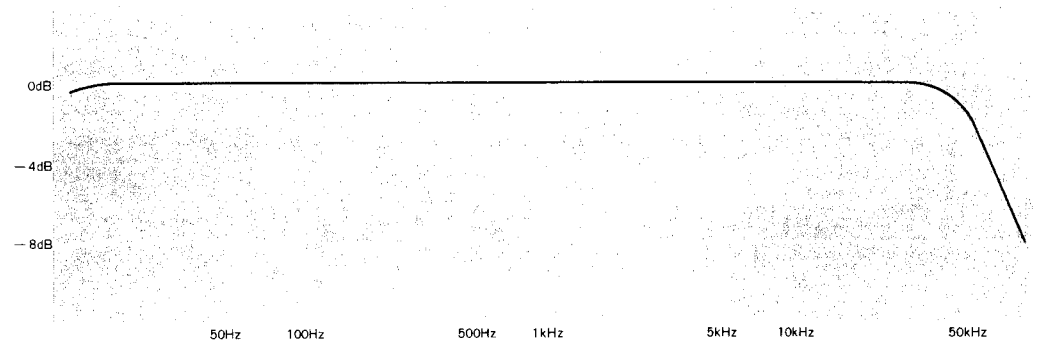

**DAMPING FACTOR** 8Ω load 1W output

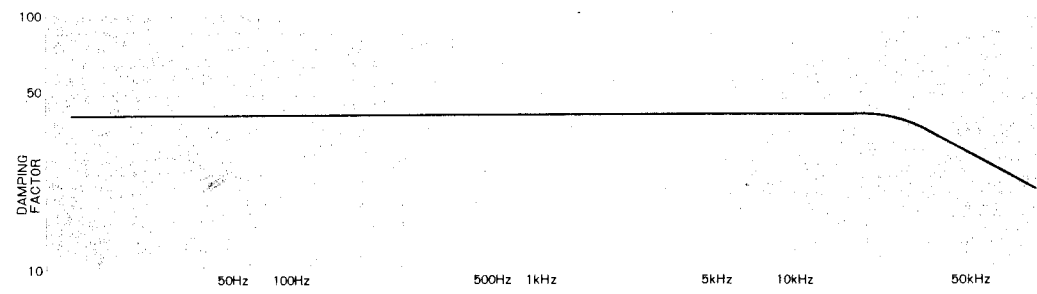

**LINEAR EQUALIZER**

(position: A - Up-tilt 2 B - Up-tilt 1, C - Flat, D - Down-tilt 1 E - Down-tilt 2)

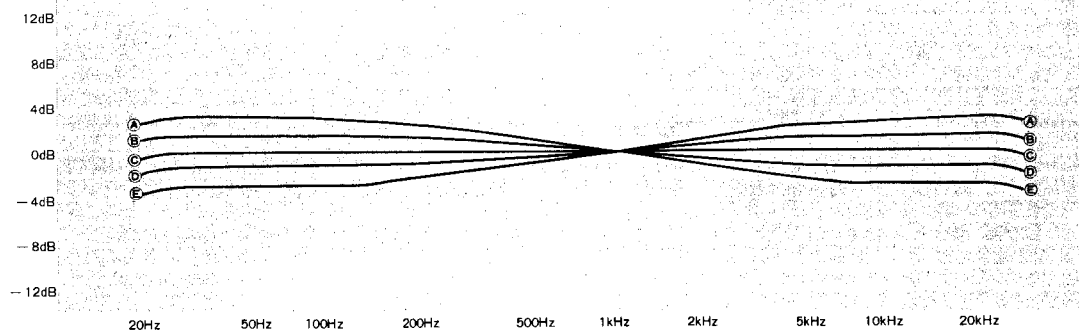

**BASS TONE CONTROL**

Turn-over (Roll-off) Frequency: 150Hz

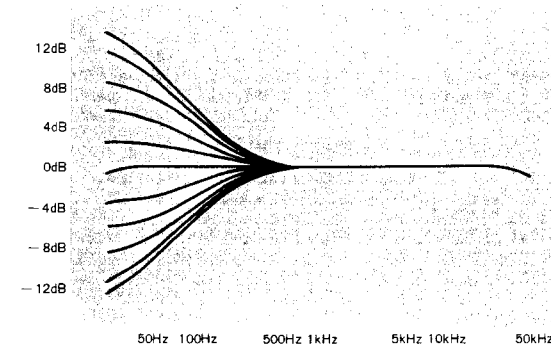

**TREBLE TONE CONTROL**

Turn-over (Roll-off) Frequency: 6kHz

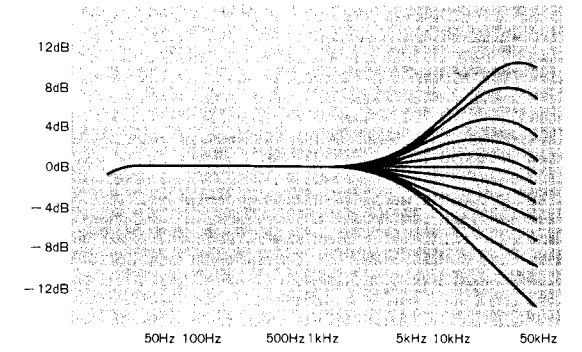

**BASS TONE CONTROL**

Turn-over (Roll-off) Frequency: 300Hz

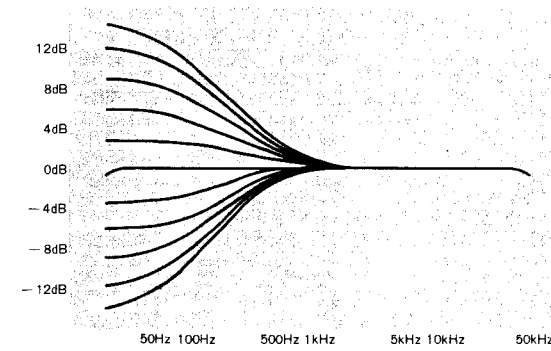

**TREBLE TONE CONTROL**

Turn-over (Roll-off) Frequency: 3kHz

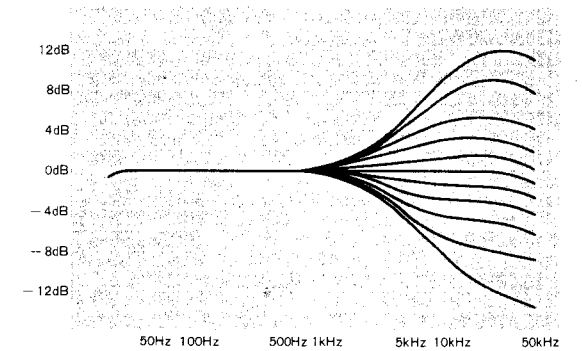

**BASS TONE CONTROL**

Turn-over (Roll-off) Frequency: 600Hz

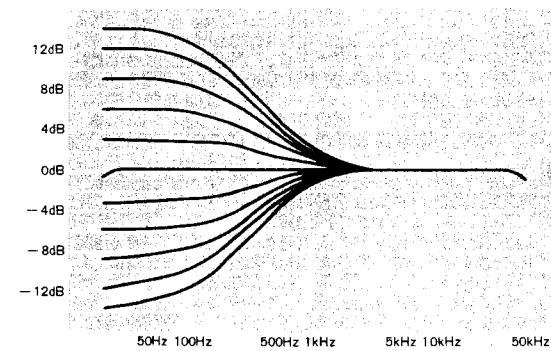

**TREBLE TONE CONTROL**

Turn-over (Roll-off) Frequency: 1.5kHz

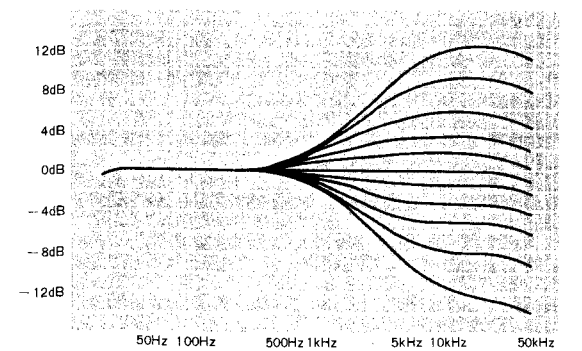

## SPECIFICATIONS

**\*Circuit:** Fully complementary direct coupled D.C. output amp utilizing dual rail supply.

**\*Main Amp**

**Power Output** 55W+55W (8 $\Omega$  both channels driven)

**(Continuous RMS):** 65W+65W (8 $\Omega$  single channel driven)

**Power Bandwidth:** 5~50,000 Hz (-3 dB, 0.03%)

**Frequency Response:** 10~50,000 Hz (within -1 dB)

**T.H.D.:** below 0.03% (8 $\Omega$ , 55W)

**Intermodulation**

**Distortion:** <0.04% (8 $\Omega$ , 55W)

**Residual Noise:** <0.5 mV (86 dB)

**Input Impedance:** 40K $\Omega$

**Input Sensitivity:** 600mV

**Damping Factor:** 40 (at 8 $\Omega$ )

**\*Pre Amp**

**Frequency Response:** 10~50,000 Hz (tuner input, -1 dB)

**T.H.D.:** below 0.03% (tuner input, 1V)

**Sensitivity:** 2.5mV (PHONO-1, PHONO-2), 100mV (AUX-1, AUX-2) 100mV (TUNER) input level is adjustable

**Max. input signal:** 300mV (PHONO, 1 KHz)

**Input Impedance:** 90K $\Omega$ , 65K $\Omega$ , 50K $\Omega$  (PHONO-2) 50K $\Omega$  (TUNER) 100K $\Omega$  (AUX-1, AUX-2)

**S/N Ratio:** Over 65 dB (PHONO-1, PHONO-2)  
Over 80 dB (TUNER, AUX-1, AUX-2)

**Tone Control:** LUX type turn-over frequency selector

<b>Treble:</b>	1.5KHz	10KHz ( $\pm$ 12dB)
	3KHz	10KHz ( $\pm$ 10dB)
	6KHz	10KHz ( $\pm$ 8dB)
<b>Bass:</b>	150Hz	100Hz ( $\pm$ 8dB)
	300Hz	100Hz ( $\pm$ 10dB)
	600Hz	100Hz ( $\pm$ 12dB)

**Filter:** Low cut, 20Hz, 70Hz (-6dB/oct.)  
High cut; 7KHz, 12KHz (-6dB/oct.)  
100Hz (6dB/oct.)

**Low Boost:**

**Special Brand-New Control:** Linear Equalizer (5 steps)

**Accessories:** Tape dubbing, Attenuator (variable adjusting type), speaker switch, tape monitor (2 sets), pre/main amp separator, headphone jack, speaker muting, etc.

**Dimensions:** 485mm(W)x300mm(D)x165mm(H)  
(19-1/8"x12"x6-5/12")

**Weight:** 12.5 kg (27.5 lbs)